

# Natural Home







*Dal progetto.....*



*.....al filo ... al divano.....*



*.....alla natura.*

# Qualità dal 1975

Seducenti e raffinate proposte di arredo high profile che da sempre caratterizzano il mood della Griffe. Una collezione all'insegna dell'eleganza, della bellezza e della qualità che definisce la ricchezza del più piccolo dettaglio: dal taglio dei rivestimenti alla cucitura; dalla produzione dei materiali all'assemblaggio finale, caparbiamente domati dalle mani e dal genio creativo dell'uomo. Impegno nella ricerca del lusso, costantemente rivolto all'innovazione nell'esecuzione e nella lavorazione del prodotto, sempre contraddistinto dal Made in Italy, sinonimo di qualità, buon gusto e tradizione. Modelli incantevoli, frutto di un'attenta indagine estetica e progettuale: preziosi nei materiali, sedicenti nella loro artigianalità, esclusivi nell'interpretazione delle nuove tendenze. La bellezza nasce dal desiderio di realizzare qualcosa che duri per sempre, attingendo dal passato per creare il futuro. Un profondo senso estetico dettato dalle forme, dai tessuti, dalle lavorazioni e dalla pura funzionalità del prodotto, che ci permette di immaginare e forse di sognare... ancora.

## QUARTET: UN'AZIENDA DI CLASSE... "VERDE"

con orgoglio che ci presentiamo come azienda "Verde" che produce energia da almeno una fonte rinnovabile, sempre attenti al rispetto dell'ambiente e ad essere più competitivi sul mercato grazie anche al risparmio energetico. I nostri impianti fotovoltaici evitano di "bruciare" ogni anno 84 Barili di petrolio ( 13.350 Litri ) e di immettere nell'atmosfera ben 87.000 Kg di CO2/anno. L'impianto fotovoltaico su tetto totalmente integrato, questo è l'ambizioso progetto che Quartet, azienda leader nel settore dell'arredo, ha portato recentemente a termine nella sua sede di Altamura (BA). Un progetto che conferma e rafforza la sensibilità dell'azienda per le tematiche della sostenibilità ambientale, ultimo passo di un percorso "Verde".

*Tempting and elegant furniture proposals high profile that has always characterized the mood of Designe. A collection of elegance, beauty and quality that defines the richness of the smallest detail, from the cutting of coverings to stitching, from material production to final assembly, stubbornly tamed by the hands and human creative genius. Commitment in the research of luxury, constantly focused on innovation in the execution and processing of the product, always marked by the Made in Italy, synonymous of quality, good taste and tradition Beautiful models, the result of careful investigation aesthetic and design: precious materials, exclusive interpretation of trends. The beauty comes from the desire to create something that will last forever, extrapolating from the past to create the future. A deep sense of aesthetics dictated by the forms, textiles, and from working from pure functionality of the product, which allows us to imagine and perhaps to dream... more.*

## QUARTET: A CLASS COMPANY... "GREEN"

*And with great pride that we present ourselves as a company "Green" that produces energy from at least a renewable source, always attentive to the environment and to be more competitive in the market thanks to the energy savings. Our photovoltaic avoid "burn" each year, 84 barrels of oil (13,350 liters) and enter the atmosphere 87,000 kg of CO2 for year. The photovoltaic roof fully integrated, this is an ambitious project that Quartet, a leader in the furniture industry, has recently completed at its headquarters in Altamura (BA). A project that confirms and reinforces the company's sensitivity to issues of environmental sustainability, the last step of a way "Green".*

*Обольстительное и изысканное предложение мебели высокого класса - постоянные характеристики марки EPOQUE. Коллекцию отличает элегантность, красота и качество, находящие воплощение в любой, даже самой маленькой детали: от края ткани до пошива, от производства материалов до финальной сборки, осуществляемой заботливыми руками и креативным гением человека. Непрерывное стремление к роскоши, всегда обращенное к инновациям в исполнении и обработке изделия, является отличительной чертой Made in Italy, ставшей синонимом качества, хорошего вкуса и традиции. Чарующие модели плод - усердного поиска в области эстетики и дизайна: ценные материалы, захватывающие своей самобытностью и эксклюзивностью в интерпретации новых моделей. Красота рождается из желания творить нечто вечное, обращается к прошлому для созидания будущего. Глубинное эстетическое чувство, продиктованное формой, материалом, обработкой, простой функциональностью изделия, позволяет нам вообразить и мечтать... снова и снова.*

*QUARTET: Фабрика "зелеНОГО" Класса. Мы гордимся тем, что являемся "зеленой" фабрикой, производящей электроэнергию из возобновляемого источника и со вниманием относящейся к состоянию окружающей среды. Экономия электроэнергии становится еще одним фактором, позволяющим нам быть более конкурентоспособными на рынке. Наши фотогальванические установки позволяют ежегодно экономить 84 барреля нефти (13.350 литров) и не выбрасывать в атмосферу более 87.000 кг углекислого газа. Установка на крыше фабрики интегрированной фотогальванической системы представляет собой амбициозный проект компании Quartet, фабрики-лидера в области производства мебели, расположенной в г. альтамура региона бари (италия). Данный проект подчеркивает трепетное отношение фабрики к проблеме состояния окружающей среды и является последним шагом на пути к "зеленым" технологиям.*



# Divani



Anice \_ 28



Bergamotto \_ 40



Citronella \_ 08



Galanga \_ 100



Ginepro \_ 62



Lavanda \_ 56

# Letti



Alloro \_ 118



Pimento \_ 128

# Poltrone



Papavero \_ 24 / 36



Pepe \_ 146

# Pouf



Cumino \_ 115



Curry \_ 114



Origano \_ 23



Paprica \_ 104



Porro \_ 12



Senape \_ 148



Cardamomo \_ 70



Carvi \_ 18



Cassia \_ 92



Cerfoglio \_ 108



Timo \_ 84



Trigonella \_ 48



Vaniglia \_ 76



Camomilla \_ 80



Curcuma \_ 140



Macis \_ 53



Noce moscata \_ 67



Tabasco \_ 112



Tiglio \_ 96



Viola \_ 15



Zafferano \_ 124



Eucalipto \_ 150

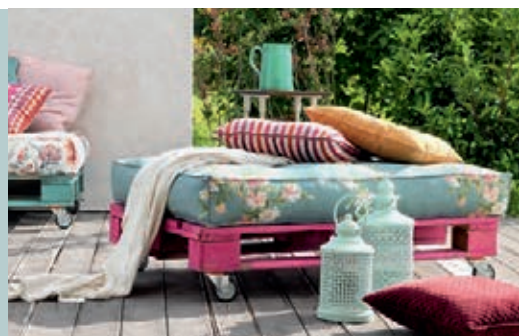

Lemongrass \_ 134



Sesamo \_ 45



Zenzero \_ 37

Separè



Pepper \_ 44

Complementi



da pagina 154 a pagina 172

Classico con Frio

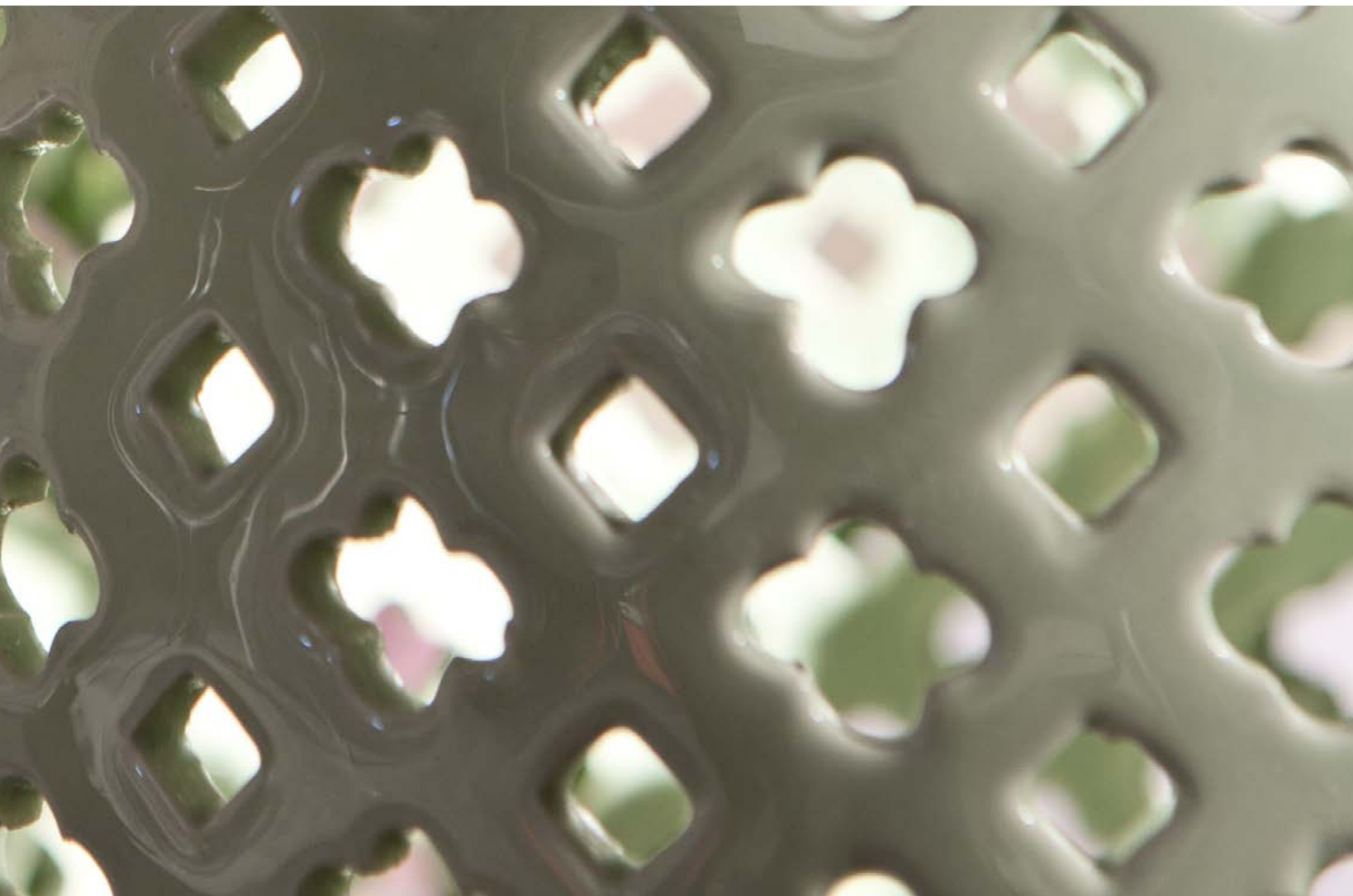









Struttura e cuscino seduta: 40BE5997 CAT. E  
Bordino: 40BE5996 CAT. E  
Cuscinetti: 40VI6008 CAT. G; 40FB5960 CAT. F  
Rullo: 40FB5953 CAT. D  
Mazza Clarke



# Pouf

*Versioni:* pouf. *Struttura:* // *Imbottitura:* in poliuretano espanso a quote e qualità differenziate, fibre poliestere. *Caratteristiche:* profili con bordino di serie; su richiesta e con costo aggiuntivo, è possibile impreziosire il pouf con l'inserimento di passamaneria nei modelli e colori previsti a catalogo.

*Versions:* pouf. *Structure:* // *Padding:* expanded polyurethane of differentiated densities and qualities, polyester fibre. *Characteristics:* profiles with fringe fittings; on request is possible choose trimmings in the colors provided in the catalog (additional cost).

*Варианты:* пуф. *Структура:* // *Набивка:* по умолчанию полиуретан средней жесткости (gomma), полистероловые волокна. *Характеристики:* отделка «bordino» по умолчанию. По запросу (за дополнительную плату) можно добавить любую представленную в каталоге бахрому.

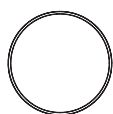

59



- A - Rivestimento: 40FB5956 CAT. F
- B - Rivestimento: 40CK5901 CAT. D  
40CK5902 CAT. G  
Passamaneria: barletta bobble 150038
- C - Rivestimento: 40CK5914 CAT. D  
40CK5908 CAT. G  
Passamaneria: cipollina ecru
- D - Rivestimento: 40AU5963 CAT. C  
Passamaneria: barletta bobble 150030  
Mazza Clarke



## Viola

*Versioni:* poltrona. *Struttura:* legno e suoi derivati, cinghie elastiche incrociate ad alta resistenza. *Imbottitura:* in poliuretano espanso a quote e qualità differenziate, fibre poliestere, cuscino in piuma d'oca. *Caratteristiche:* interamente sfoderabile; piedi a vista nei colori previsti a catalogo.

*Versions:* armchair. *Structure :* in wood and by-products, high resistant strength woven elastic belts. *Padding :* expanded polyurethane of differentiated densities and qualities , polyester fibre,goose pillows . *Characteristics :* removable covering ;visible legs colors provided in the catalog.

*Варианты:* кресло. *Структура:* дерево и его производные, перекрещенные эластичные ремни высокой прочности. *Набивка:* по умолчанию полиуретан средней жесткости (gomma), полистероловые волокна. Подушка с набивкой из гусиного пуха. *Характеристики:* полностью съемный чехол, видимые ножки в серийных отделках.

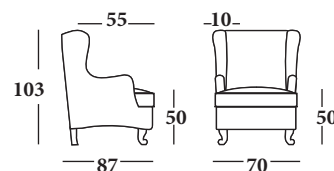



Rivestimento: 40AU5963 CAT. C  
Mazza Clarke

Tradizione e Design









Rivestimento: 40ID4831 CAT. E  
Bordino: 40ID4830 CAT. E  
Mazza Uniti







## Origano

*Versioni:* pouf con piano in vetro temperato. *Struttura:* legno e suoi derivati. *Imbottitura:* in poliuretano espanso a quote e qualità differenziate, fibre poliestere. *Caratteristiche:* con chiodini di serie; piedi parzialmente a vista nei colori previsti a catalogo.

*Versions:* pouf. *Structure:* in wood and by-products. *Padding:* expanded polyurethane of differentiated densities and qualities, polyester fibre. *Characteristics:* with a nails; partially visible feet in the colors provived in the catalog.

*Варианты:* пуф со столешницей из закаленного стекла. *Структура:* дерево и его производные. *Набивка:* по умолчанию полиуретан средней жесткости (gomma), полистероловые волокна. *Характеристики:* отделка гвоздиками по умолчанию, частично видимые ножки в серийных отделках.

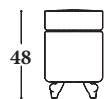

Rivestimento: 40ID4831 CAT. E  
Mazza Uniti  
Finitura: bianco COL. 28



# Papavero

*Versioni:* poltrona, divano 2 posti e pouf. *Struttura:* legno e suoi derivati, cinghie elastiche incrociate ad alta resistenza. *Imbottitura:* in poliuretano espanso a quote e qualità differenziate, fibre poliestere. Su richiesta, è possibile personalizzare le imbottiture. *Caratteristiche:* la finitura della struttura in legno è disponibile nei colori previsti a catalogo.

*Versions:* armchair, 2 seater sofa and pouf. *Structure:* in wood and by-products, high resistant strength woven elastic belts.

*Padding:* expanded polyurethane of differentiated densities and qualities, polyester fibre. On request is possible choose the padding (additional cost).

*Characteristics:* finishing for base in wood is available in different colors in the catalog.

*Варианты:* кресло, диван 2-х местный, пуф. *Структура:* дерево и его производные, перекрещенные эластичные ремни высокой прочности.

*Набивка:* по умолчанию полиуретан средней жесткости (gomma), полистероловые волокна. По запросу можно изменить тип наполнения подушек сидения (за дополнительную плату). *Характеристики:* окраска деревянного каркаса в серийных отделках.

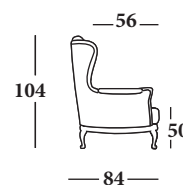

seduta avanti L 55



seduta avanti L 112

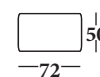



Rivestimento: 40FB5956 CAT. F  
Finitura: naturale  
Mazza Clarke

Fascino e Comfort









**Materasso in fibra poliuretana h. 17 cm.**

**Polyurethane mattress of 17 cm.**

**Полиуретановым матрасом 17 см.**









# Arise

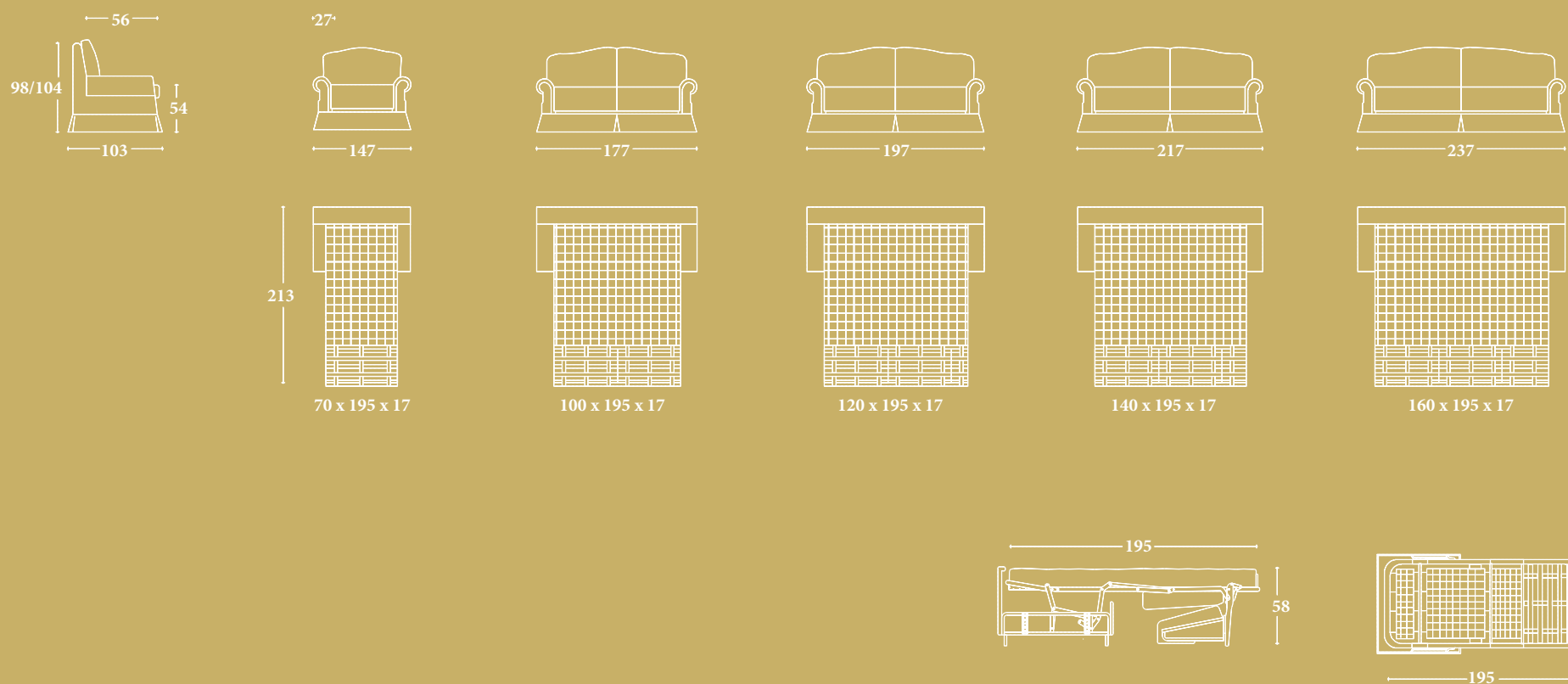

**Versioni:** poltrona, 2 posti, 2 posti e mezzo, 3 posti e 3 posti e mezzo. La poltrona, il divano 2 posti, 2 posti e mezzo, 3 posti e 3 posti e mezzo è disponibile nella versione letto con rete elettrosaldata e materasso in fibra poliuretana h. 17 cm. **Struttura:** legno e suoi derivati, cinghie elastiche incrociate ad alta resistenza. Nelle versione senza letto, il supporto della seduta può essere fornito con molle elicoidali con costo aggiuntivo. **Imbottitura:** in poliuretano espanso a quote e qualità differenziate, fibre poliestere. Su richiesta, è possibile personalizzare l'imbottitura con relativi costi aggiuntivi. **Caratteristiche:** con balza e profili con bordino di serie.

**Versions:** armchair, 2-seater sofa, 2 1/2-seater sofa, 3-seater sofa, 3 1/2-seater sofa. The armchair, 2-seater sofa, 2 1/2-seater sofa, 3-seater sofa and 3 1/2-seater sofa available in bed version with electrowelded frame and polyurethane mattress of 17 cm. **Structure:** in wood and by-products, high resistant strength woven elastic belts. In the version without bed, the seat support can be with helicoidal springs (additional cost). **Padding:** expanded polyurethane of differentiated densities and qualities, polyester fibre. On request is possible choose the padding (additional cost). **Characteristics:** with volant and profiles with fringe fittings.

**Varianti:** кресло, диван 2-х, 2 1/2, 3-х, 3 1/2 местный. Кресло, диваны 2-х, 2 1/2, 3-х, 3 1/2 местные могут быть укомплектованы раскладным механизмом с металлической решеткой и полиуретановым матрасом 17 см. **Структура:** дерево и его производные, перекрещенные эластичные ремни высокой прочности. По запросу каркас дивана может быть укомплектован спиральными пружинами (за дополнительную плату) только в версии без раскладного механизма. **Набивка:** по умолчанию полиуретан средней жесткости (gomma), полистероловые волокна. По запросу можно изменить тип наполнения подушек сидения (за дополнительную плату). **Характеристики:** декоративная юбка, отделка «bordino» по умолчанию.



Rivestimento: 40BE5996 CAT. E  
Mazza Clarke



Cuscino: 40CK 5896 LUSO  
 Finitura: COL. 28 bianco  
 Mazza Clarke

# Zenzero

*Versioni:* pouf. *Struttura:* base legno. *Imbottitura:* in poliuretano espanso a quote e qualità differenziate, fibre poliestere. Su richiesta, è possibile personalizzare l'imbottitura. *Caratteristiche:* la finitura della base in legno è disponibile nei colori previsti a catalogo; cuscino con bottoni fissato alla base con graziosi laccetti.

*Versions:* pouf. *Structure:* wooden base. *Padding:* expanded polyurethane of differentiated densities and qualities, polyester fibre. On request, is possible choose the padding (additional cost). *Characteristics:* painting the wooden base is available in the colors provided in the catalog; cushion with buttons attached to the base by laces.

*Варианты:* пуф. *Структура:* основание из дерева. *Набивка:* по умолчанию полиуретан средней жесткости (gomma), полистероловые волокна. По запросу можно изменить тип наполнения подушек сидения (за дополнительную плату). *Характеристика:* окраска деревянного каркаса в серийных отделках. Подушка с пуговицами прикрепляется к основанию с помощью тесьмы.

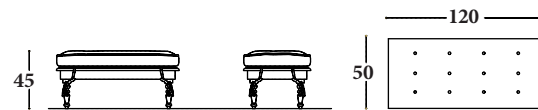

# Papavero

*Versioni:* poltrona, divano 2 posti e pouf. *Struttura:* legno e suoi derivati, cinghie elastiche incrociate ad alta resistenza. *Imbottitura:* in poliuretano espanso a quote e qualità differenziate, fibre poliestere. Su richiesta, è possibile personalizzare le imbottiture. *Caratteristiche:* la finitura della struttura in legno è disponibile nei colori previsti a catalogo.

*Versions:* armchair, 2 seater sofa and pouf. *Structure:* in wood and by-products, high resistant strength woven elastic belts. *Padding:* expanded polyurethane of differentiated densities and qualities, polyester fibre. On request is possible choose the padding (additional cost). *Characteristics:* finishing for base in wood is available in different colors in the catalog.

*Варианты:* кресло, диван 2-х местный, пуф. *Структура:* дерево и его производные, перекрещенные эластичные ремни высокой прочности. *Набивка:* по умолчанию полиуретан средней жесткости (gomma), полистероловые волокна. По запросу можно изменить тип наполнения подушек сидения (за дополнительную плату). *Характеристики:* окраска деревянного каркаса в серийных отделках.

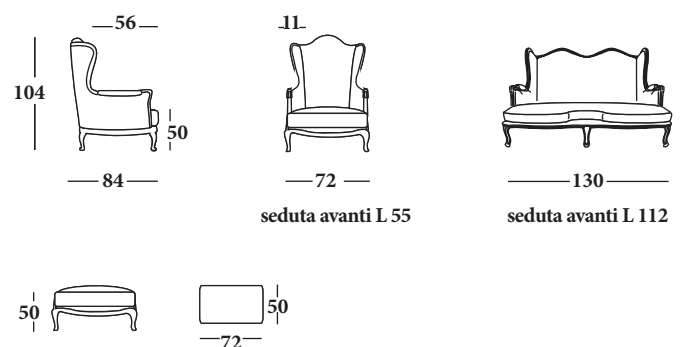



Cuscino: 40GU5989 CAT. G

Bottoni e laccetti: 40AU5963 CAT. G

Finitura: RAL 4009 viola pastello

Mazza Clarke

N.B.: la trapuntatura è una caratteristica propria del tessuto

Atmosfera Romantica









# Bergamotto

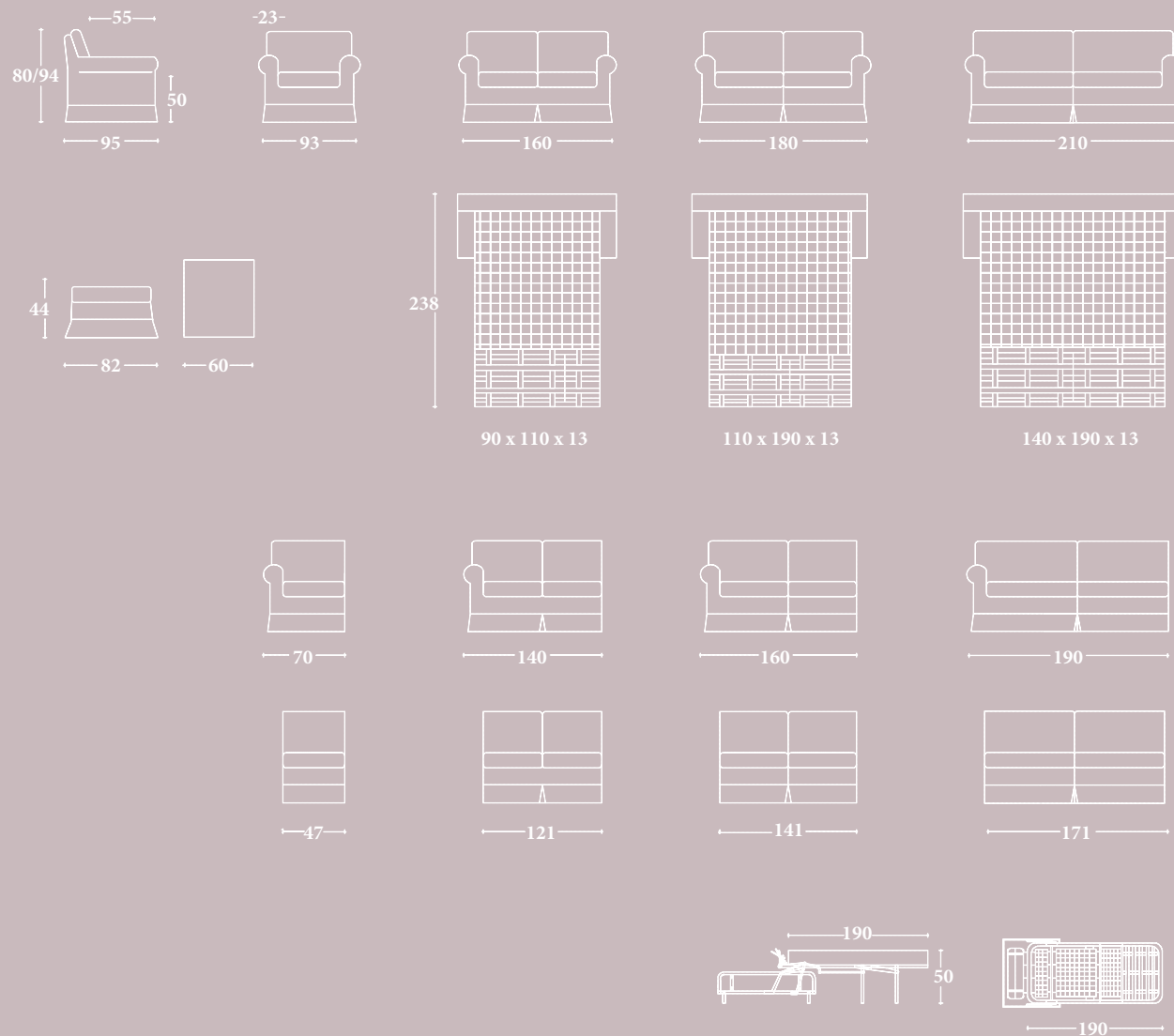

**Versioni:** poltrona, divano 2 posti, 2 posti e mezzo, 3 posti, pouf e versioni componibili con angolo tondo. Il divano 2 posti, 2 posti e mezzo e 3 posti è disponibile nella versione letto con rete elettrosaldata e materasso in fibra poliuretanica h. 13 cm. **Struttura:** legno e suoi derivati, cinghie elastiche incrociate ad alta resistenza. Nelle versioni senza letto, il supporto della seduta può essere fornito con molle elicoidali con costo aggiuntivo. **Imbottitura:** in poliuretano espanso a quote e qualità differenziate, fibre poliestere. Su richiesta, è possibile personalizzare l'imbottitura con relativi costi aggiuntivi. **Caratteristiche:** interamente sfoderabile; con balza e profili con bordino di serie.

**Versions:** armchair, 2-seater sofa, 2 1/2-seater sofa, 3-seater sofa, pouf and sectional version with round corner. The 2-seater sofa, 2 1/2-seater sofa and 3-seater sofa available in bed version with electrowelded frame and polyurethane mattress of 13 cm. **Structure:** in wood and by-products, high resistant strength woven elastic belts. In the version without bed, the seat support can be with helicoidal springs (additional cost). **Padding:** expanded polyurethane of differentiated densities and qualities, polyester fibre. On request is possible choose the padding (additional cost). **Characteristics:** removable covering, with volant and profiles with fringe fittings.

**Varianti:** кресло, диван 2-х, 2 1/2, 3-х местный, пуф, модульные композиции с закругленным углом. Диваны 2-х, 2 1/2, 3-х местные могут быть укомплектованы раскладным механизмом с металлической решеткой и полиуретановым матрасом 13 см. **Структура:** дерево и его производные, перекрещенные эластичные ремни высокой прочности. По запросу каркас дивана может быть укомплектован спиральными пружинами (за дополнительную плату) только в версии без раскладного механизма. **Набивка:** по умолчанию полиуретан средней жесткости (gomma), полистероловые волокна. По запросу можно изменить тип наполнения подушек сидения (за дополнительную плату). **Характеристики:** полностью съемный чехол, декоративная юбка, отделка «bordino» по умолчанию.



Rivestimento: 40EW5992 CAT. D  
Mazza Clarke



Rivestimento: 40EW5992 CAT. D  
Finitura: COL. 29 bianco antico  
Mazza Clarke

# Pepper

*Versioni:* separé ad ante. *Struttura:* legno e suoi derivati. *Imbottitura:* in poliuretano espanso a quote e qualità differenziate, fibre poliestere. *Caratteristiche:* la finitura della struttura in legno è disponibile nei colori previsti a catalogo.

*Versions:* separé. *Structure:* in wood and by-products. *Padding:* expanded polyurethane of differentiated densities and qualities, polyester fibre. *Characteristics:* painting the wooden base is available in the colors provided in the catalog.

*Варианты:* раздвижная ширма. *Структура:* дерево и его производные. *Набивка:* по умолчанию полиуретан средней жесткости (gomma), полистероловые волокна. *Характеристики:* окраска деревянной структуры в серийных отделках.



Rivestimento: 40AU5967 CAT. C  
Bordino e bottone: 40AU5961 CAT. C  
Mazza Clarke

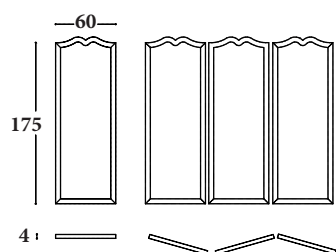

# Sesamo

*Versioni:* pouf. *Struttura:* legno e suoi derivati. *Imbottitura:* in poliuretano espanso a quote e qualità differenziate, fibre poliestere. *Caratteristiche:* profili con bordino di serie; su richiesta e con costo aggiuntivo, è possibile impreziosire il pouf con l'inserimento di passamaneria nei modelli e colori previsti a catalogo.

*Versions:* pouf. *Structure:* in wood and by-products. *Padding:* expanded polyurethane of differentiated densities and qualities, polyester fibre. *Characteristics:* profiles with fringe fittings; on request is possible choose trimmings in the colors provided in the catalog (additional cost).

*Варианты:* пуф. *Структура:* дерево и его производные. *Набивка:* по умолчанию полиуретан средней жесткости (gomma), полистероловые волокна. *Характеристики:* отделка «bordino» по умолчанию. По запросу (за дополнительную плату) можно добавить любую представленную в каталоге бахрому.

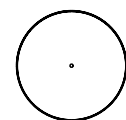
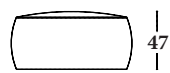

114



A close-up photograph of a blue textured fabric, possibly a sweater or blanket. A beige and red striped ribbon is sewn along the edge, with three red buttons visible. The text "Momenti di Relax" is overlaid in a white cursive font.

Momenti di Relax





# Trigonella



100 versione senza letto  
105 versione letto

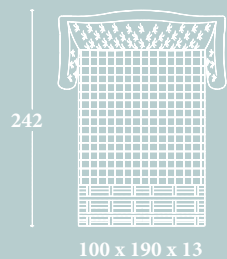
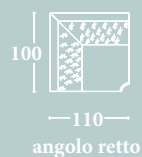
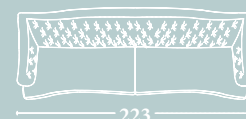
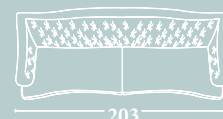
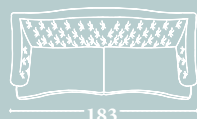
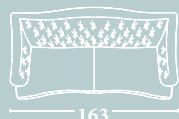

100 x 190 x 13

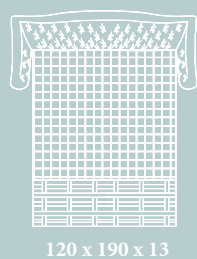

120 x 190 x 13

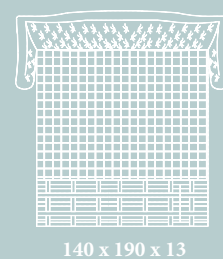

140 x 190 x 13

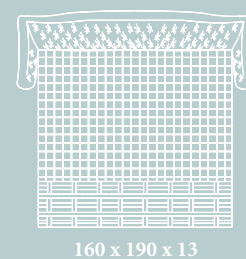

160 x 190 x 13



80

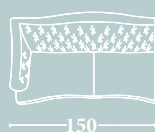

150

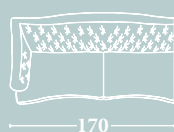

170

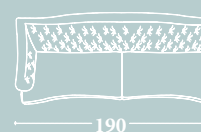

190

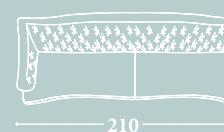

210



66

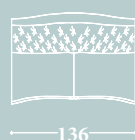

136

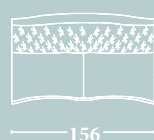

156

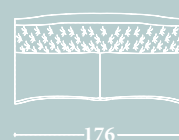

176

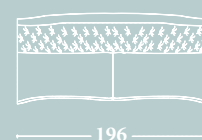

196

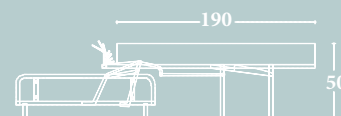

190

**Versioni:** poltrona, divano 2 posti, 2 posti e mezzo, 3 posti, 3 posti e mezzo e versioni componibili con angolo retto o angolo tondo. Il divano 2 posti, 2 posti e mezzo, 3 posti e 3 posti e mezzo è disponibile nella versione letto con rete elettrosaldata e materasso in fibra poliuretana h. 13 cm.

**Struttura:** legno e suoi derivati, cinghie elastiche incrociate ad alta resistenza. Nelle versioni senza letto, il supporto della seduta può essere fornito con molle elicoidali con costo aggiuntivo. **Imbottitura:** in poliuretano espanso a quote e qualità differenziate, fibre poliestere. Su richiesta, è possibile personalizzare l'imbottitura con relativi costi aggiuntivi.

**Caratteristiche:** con balza e profili con bordino di serie

**Versions:** armchair, 2-seater sofa, 2 1/2-seater sofa, 3-seater sofa, 3 1/2-seater sofa and sectional versions with square and round corner. The 2-seater sofa, 2 1/2-seater sofa, 3-seater sofa and 3 1/2 seater sofa available in bed version with electrowelded frame and polyurethane mattress of 13 cm. **Structure:** in wood and by-products, high resistant strength woven elastic belts. In the version without bed, the seat support can be with helicoidal springs (additional cost). **Padding:** expanded polyurethane of differentiated densities and qualities, polyester fibre. On request is possible choose the padding (additional cost). **Characteristics:** with volant and profiles with fringe fittings.

**Varianti:** кресло, диван 2-х, 2 ½, 3-х, 3 ½ местный, модульные композиции с прямым или закругленным углом. Диваны 2-х, 2 ½, 3-х, 3 ½ местные могут быть укомплектованы раскладным механизмом с металлической решеткой и полиуретановым матрасом 13 см. **Структура:** дерево и его производные, перекрещенные эластичные ремни высокой прочности. По запросу каркас дивана может быть укомплектован спиральными пружинами (за дополнительную плату) только в версии без раскладного механизма. **Набивка:** по умолчанию полиуретан средней жесткости (gomma), полистероловые волокна. По запросу можно изменить тип наполнения подушек сидения (за дополнительную плату). **Характеристики:** декоративная юбка, отделка «bordino» по умолчанию.



Rivestimento: 40FB5955 CAT. F  
Mazza Clarke





# Maeis

*Versioni:* poltrona. *Struttura:* legno e suoi derivati, cinghie elastiche incrociate ad alta resistenza. *Imbottitura:* in poliuretano espanso a quote e qualità differenziate, fibre poliestere. *Caratteristiche:* interamente sfoderabile.

*Versions:* armchair. *Structure:* in wood and by-products, high resistant strength woven elastic belts. *Padding:* expanded polyurethane of differentiated densities and qualities, polyester fibre. *Characteristics:* removable covering.

*Варианты:* кресло. *Структура:* дерево и его производные, перекрещенные эластичные ремни высокой прочности. *Набивка:* по умолчанию полиуретан средней жесткости (gomma), полистероловые волокна. *Характеристики:* полностью съемный чехол.

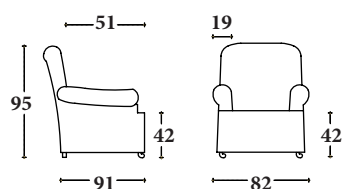

Rivestimento: 40ID4831 CAT. E  
Mazza Uniti

Stile senza Tempo











Rivestimento: 40MC5890 CAT. G  
Mazza Clarke



*Diwani da Nivere*

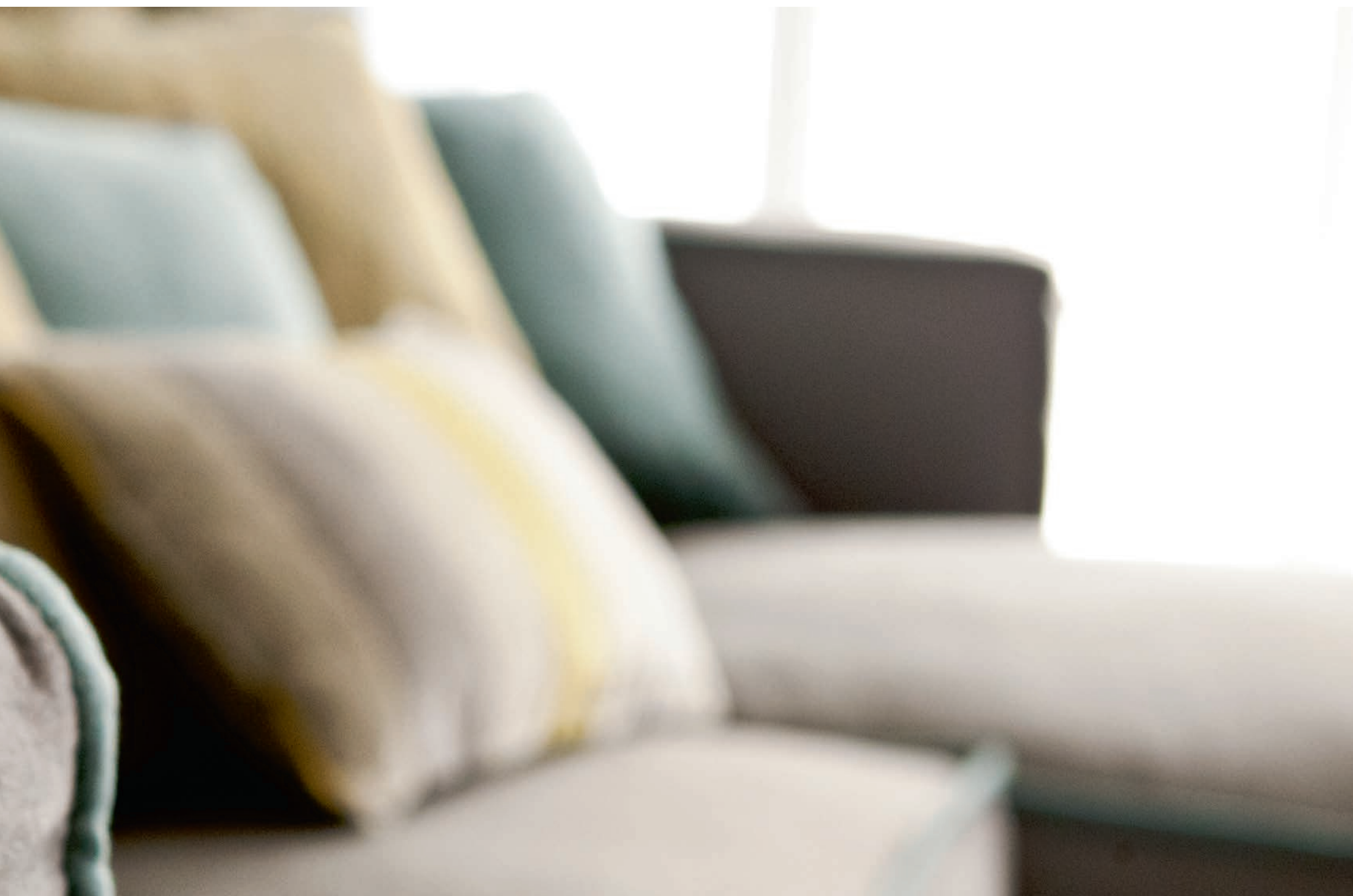





# Pinepro

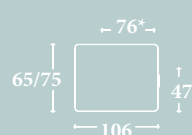

\*senza cuscinetti

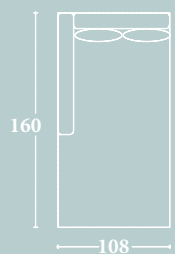

chaise longue

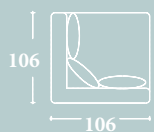

angolo retto

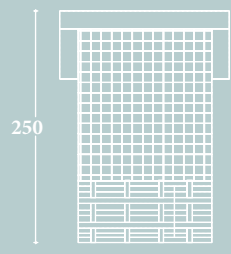

100 x 190 x 13

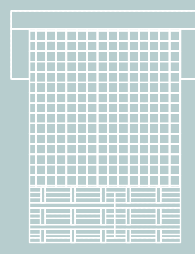

120 x 190 x 13

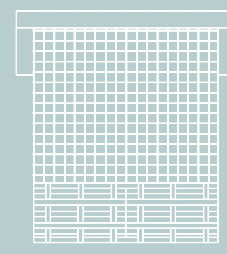

140 x 190 x 13

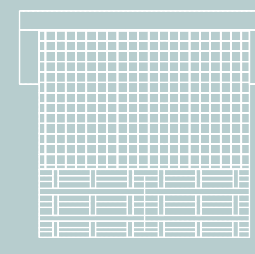

160 x 190 x 13



92



152



172



202



232



75



135



155



185



215



190

50



190

**Versioni:** poltrona, divano 2 posti, 2 posti e mezzo, 3 posti, 3 posti e mezzo e versioni componibili con angolo retto e chaise longue. Il divano 2 posti, 2 posti e mezzo, 3 posti e 3 posti e mezzo è disponibile nella versione letto con rete elettrosaldata e materasso in fibra poliuretana h. 13 cm. **Struttura:** legno e suoi derivati, cinghie elastiche incrociate ad alta resistenza. Nelle versioni senza letto, il supporto della seduta può essere fornito con molle elicoidali con costo aggiuntivo. **Imbottitura:** in poliuretano espanso a quote e qualità differenziate, fibre poliestere. Su richiesta è possibile personalizzare le imbottiture. **Caratteristiche:** interamente sfoderabile; cuscinetti di serie; profili con bordino grosso di serie.

**Versions:** armchair, 2-seater sofa, 3-seater, 3 1/2 seater and sectional version with right corner and chaise longue. The 2-seater sofa, 2 1/2-seater, 3-seater and 3 1/2 seater available in bed version with electrowelded frame and polyurethane mattress of 13 cm. **Structure:** in wood and by-products, high resistant strength woven elastic. In the version without bed, the seat support can be with helicoidal springs (additional cost). **Padding:** expanded polyurethane of differentiated densities and qualities, polyester fibre. On request is possible choose the padding (additional cost). **Characteristics:** removable covering; pillows included; profiles piping series.

**Varianti:** кресло, диван 2-х, 2 1/2, 3-х, 3 1/2 местный, модульные композиции с прямым углом. Диваны 2-х, 2 1/2, 3-х, 3 1/2 местные могут быть укомплектованы раскладным механизмом с металлической решеткой и полиуретановым матрасом 13 см. **Структура:** дерево и его производные, перекрещенные эластичные ремни высокой прочности. По запросу каркас дивана может быть укомплектован спиральными пружинами (за дополнительную плату) только в версии без раскладного механизма. **Набивка:** по умолчанию полиуретан средней жесткости (gomma), полистероловые волокна. По запросу можно изменить тип наполнения подушек сидения (за дополнительную плату). **Характеристики:** полностью съемный чехол, декоративные подушечки, отделка «bordino grosso» по умолчанию.



Rivestimento: 40ID4837 CAT. E  
Profili e cuscini: 40ID4832 CAT. E  
Mazza Uniti  
Cuscini: 40FB5956 CAT. F; 40GU5984 LUSO  
Mazza Clarke



## Noce Moseata

*Versioni:* poltrona. *Struttura:* legno e suoi derivati, cinghie elastiche incrociate ad alta resistenza. *Imbottitura:* in poliuretano espanso a quote e qualità differenziate, fibre poliestere. *Caratteristiche:* piedi a vista nei colori previsti a catalogo e profili con bordino di serie.

*Versions:* armchair. *Structure:* in wood and by-products, high resistant strength woven elastic belts. *Padding:* expanded polyurethane of differentiated densities and qualities, polyester fibre. *Characteristics:* finishing for legs is available in different colors in catalog.

*Варианты:* кресло. *Структура:* дерево и его производные, перекрещенные эластичные ремни высокой прочности. *Набивка:* по умолчанию полиуретан средней жесткости (gomma), полистероловые волокна. *Характеристики:* видимые ножки в серийных отделках, отделка «bordino» по умолчанию.

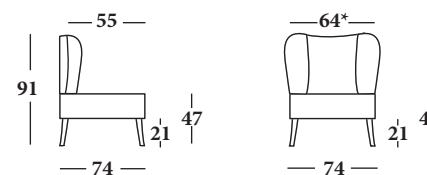

\* Avanti seduta L cm 64





Profumo di Charme











Rivestimento: 40FB5952 CAT. D  
Finitura: col. 30 scrape white  
Mazza Clarke



A photograph of a sofa with a grey tufted cushion and a purple pillow, with the text "Dettagli armoniosi" overlaid in a white script font.

*Dettagli armoniosi*





# Vaniglia

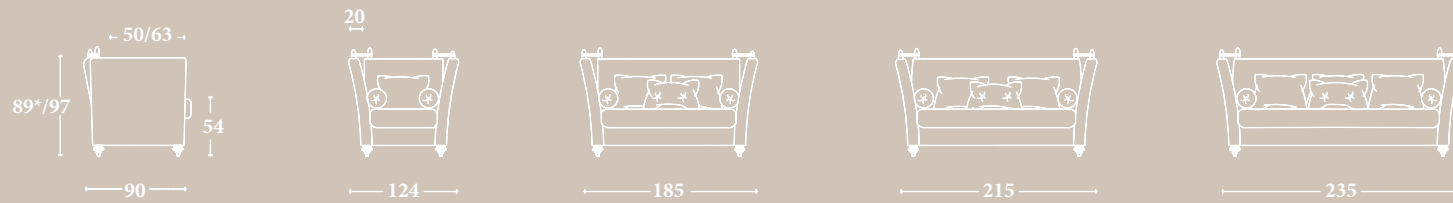

\*misura senza pigne

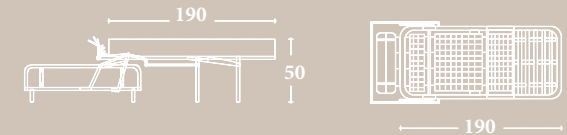
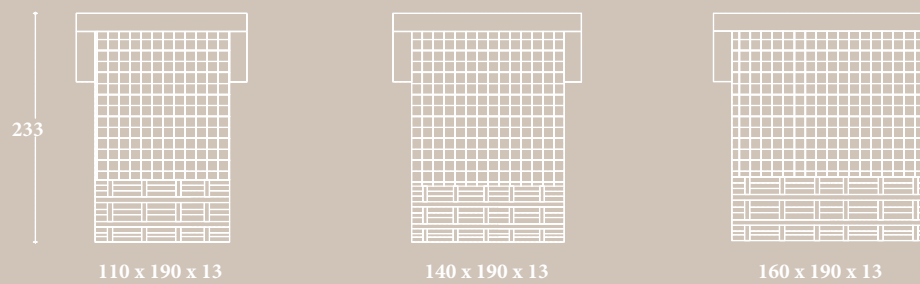
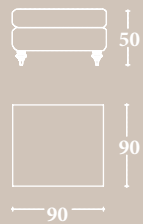

**Versioni:** poltrona, divano 2 posti, 2 posti e mezzo, 3 posti e pouf. Il divano 2 posti, 2 posti e mezzo e 3 posti è disponibile nella versione letto con rete elettrosaldata e materasso in fibra poliuretana h. 13 cm. **Struttura:** legno e suoi derivati, cinghie elastiche incrociate ad alta resistenza. Nelle versioni senza letto, il supporto della seduta può essere fornito con molle elicoidali con costo aggiuntivo. **Imbottitura:** in poliuretano espanso a quote e qualità differenziate, fibre poliestere. Su richiesta, è possibile personalizzare l'imbottitura con relativi costi aggiuntivi. **Caratteristiche:** seduta con cuscino intero; cuscinetti e rulli di serie; versione con piedi a vista di serie.

**Versions:** armchair, 2-seater sofa, 2 1/2-seater sofa, 3-seater sofa and pouf. The 2-seater sofa, 2 1/2-seater sofa and 3-seater sofa available in bed version with electrowelded frame and polyurethane mattress of 13 cm. **Structure:** in wood and by-products, high resistant strength woven elastic belts. In the version without bed, the seat support can be with helicoidal springs (additional cost). **Padding:** expanded polyurethane of differentiated densities and qualities, polyester fibre. On request is possible choose the padding (additional cost). **Characteristics:** entire sitting cushion; pillows and rollers included.

**Варианты:** кресло, диван 2-х, 2 ½, 3-х местный, пуф. Диваны 2-х, 2 ½, 3-х местные могут быть укомплектованы раскладным механизмом с металлической решеткой и полиуретановым матрасом 13 см. **Структура:** дерево и его производные, перекрещенные эластичные ремни высокой прочности. По запросу каркас дивана может быть укомплектован спиральными пружинами (за дополнительную плату) только в версии без раскладного механизма. **Набивка:** по умолчанию полиуретан средней жесткости (gomma), полистероловые волокна. По запросу можно изменить тип наполнения подушек сидения (за дополнительную плату). **Характеристики:** единая подушка сидения, декоративные подушечки и валики, серийные видимые ножки.



Rivestimento e due cuscini: 40AU5961 CAT. C  
Cuscino seduta e cuscino con bottoni: 40FB5955 CAT. F  
Rullo e cuscino: 40AU5962 CAT. C, bottone 40FB5955 CAT. F  
Mazza Clarke



## Camomilla

*Versioni:* poltrona e divano 2 posti. *Struttura:* legno e suoi derivati, cinghie elastiche incrociate ad alta resistenza. *Imbottitura:* in poliuretano espanso a quote e qualità differenziate, fibre poliestere. *Caratteristiche:* la finitura dei piedi e dei supporti in legno dei braccioli è disponibile nei colori previsti a catalogo.

*Versions:* armchair and 2 seater sofa. *Structure:* in wood and by-products, high resistant strength woven elastic belts. *Padding:* expanded polyurethane of differentiated densities and qualities, polyester fibre. *Characteristics:* finishing for legs and wooden supports of the arms is available in different colors in catalog.

*Варианты:* кресло, диван 2-х местный. *Структура:* дерево и его производные, перекрещенные эластичные ремни высокой прочности. *Набивка:* по умолчанию полиуретан средней жесткости (gomma), полистероловые волокна. *Характеристики:* окраска ножек и деревянных элементов подлокотника в серийных отделках.

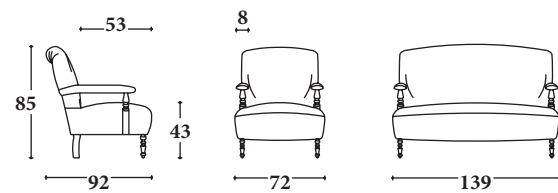



Rivestimento: 40PR5950 CAT. E  
Finitura: Cerase seppia colore 42  
Mazza Chantilly

Look raffinato

















Rivestimento: 40BE6003 CAT. E

Bordino: 40AU5964 CAT. C

Cuscini: 40MC5890 CAT. G

Mazza Clarke

Finitura: bianco opaco

*Design Attuale*









# Cassia

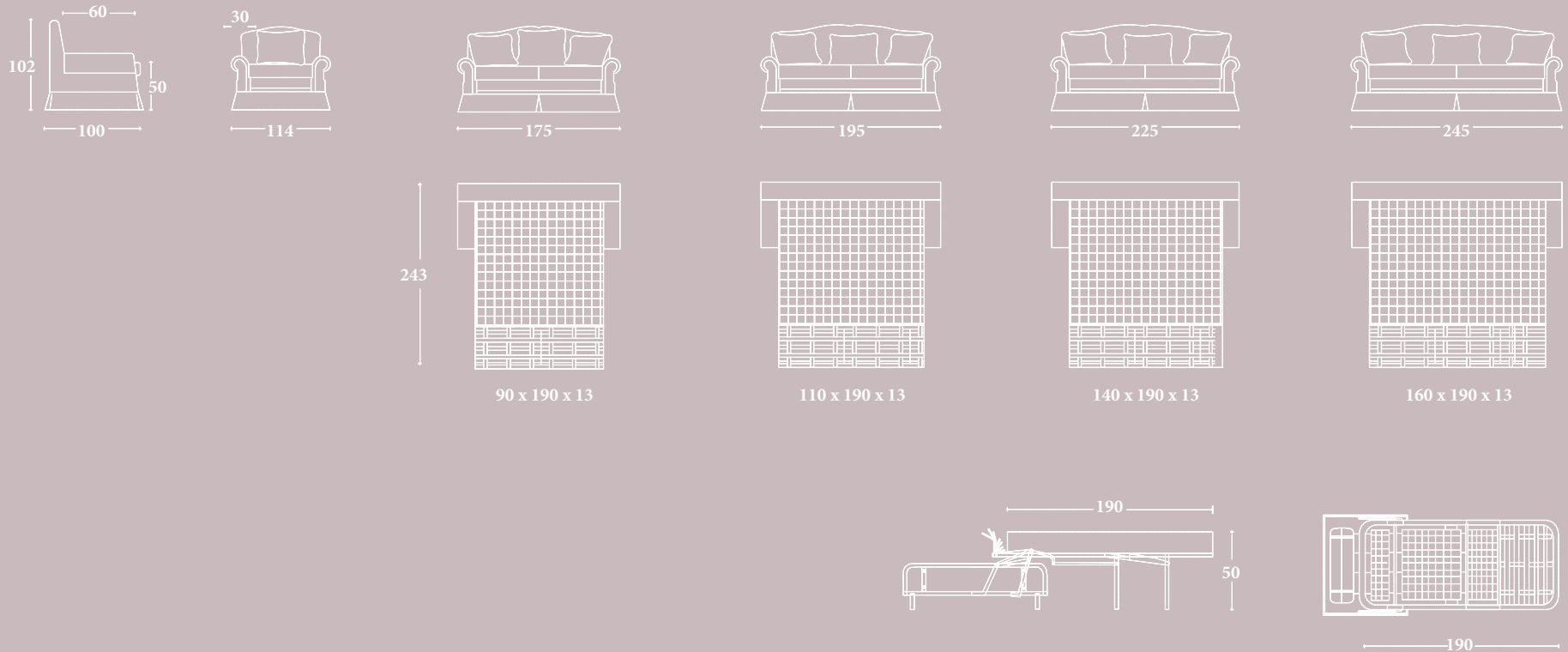

*Versioni:* poltrona, divano 2 posti, 2 posti e mezzo, 3 posti e 3 posti e mezzo. Il divano 2 posti, 2 posti e mezzo, 3 posti e 3 posti e mezzo è disponibile nella versione letto con rete elettrosaldata e materasso in fibra poliuretana h. 13 cm. *Struttura:* legno e suoi derivati, cinghie elastiche incrociate ad alta resistenza. Nelle versioni senza letto, il supporto della seduta può essere fornito con molle elicoidali con costo aggiuntivo. *Imbottitura:* in poliuretano espanso a quote e qualità differenziate, fibre poliestere. Su richiesta, è possibile personalizzare l'imbottitura con relativi costi aggiuntivi. *Caratteristiche:* cuscini di serie; con balza e profili con bordino di serie.

*Versions:* armchair, 2-seater sofa, 2 1/2-seater sofa, 3-seater sofa, 3 1/2-seater sofa. The 2-seater sofa, 2 1/2-seater, 3-seater and 3 1/2 seater available in bed version with electrowelded frame and polyurethane mattress of 13 cm. *Structure:* in wood and by-products, high resistant strength woven elastic belts. In the version without bed, the seat support can be with helicoidal springs (additional cost). *Padding:* expanded polyurethane of differentiated densities and qualities, polyester fibre. On request is possible choose the padding (additional cost). *Characteristics:* pillows included; with volant and profiles with fringe fittings.

*Варианты:* кресло, диван 2-х, 2 ½, 3-х, 3 ½ местный. Диваны 2-х, 2 ½, 3-х, 3 ½ местных могут быть укомплектованы раскладным механизмом с металлической решеткой и полиуретановым матрасом 13 см. *Структура:* дерево и его производные, перекрещенные эластичные ремни высокой прочности. По запросу каркас дивана может быть укомплектован спиральными пружинами (за дополнительную плату) только в версии без раскладного механизма. *Набивка:* по умолчанию полиуретан средней жесткости (gomma), полистероловые волокна. По запросу можно изменить тип наполнения подушек сидения (за дополнительную плату). *Характеристики:* декоративные подушечки, декоративная юбка, отделка «bordino» по умолчанию.



Rivestimento: 40CK5909 LUSO  
Bordino: 40CK5914 CAT. D  
Cuscino: 40CK5913 CAT. F  
Mazza Clarke



## Tiglio

*Versioni:* poltrona, divano 2 posti, 3 posti e pouf. *Struttura:* legno e suoi derivati, cinghie elastiche incrociate ad alta resistenza. *Imbottitura:* in poliuretano espanso a quote e qualità differenziate, fibre poliestere. Su richiesta, è possibile personalizzare le imbottiture. *Caratteristiche:* la finitura della struttura in legno è disponibile nei colori previsti a catalogo.

*Versions:* armchair, 2 seater sofa, 3 seater sofa and pouf. *Structure:* in wood and by-products, high resistant strength woven elastic belts. *Padding:* expanded polyurethane of differentiated densities and qualities, polyester fibre. On request is possible choose the padding (additional cost). *Characteristics:* finishing for base in wood is available in different colors in the catalog.

*Варианты:* кресло, диван 2-х, 3-х местный, пуф. *Структура:* дерево и его производные, перекрещенные эластичные ремни высокой прочности. *Набивка:* по умолчанию полиуретан средней жесткости (gomma), полистероловые волокна. По запросу можно изменить тип наполнения подушек сидения (за дополнительную плату). *Характеристики:* окраска деревянного каркаса в серийных отделках.

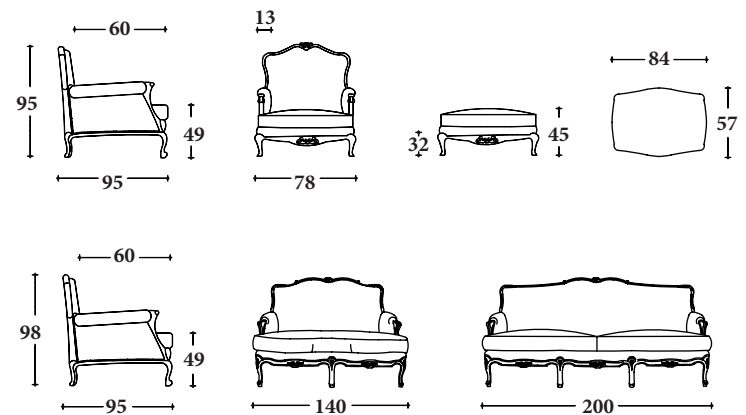



Rivestimento: 40CK5910 CAT. F  
Finitura: bianco colore 28  
Mazza Clarke



# *Evoluzione di Stile*











Rivestimento: 40BE6001 CAT. E  
Bordino: 40FB5954 CAT. D  
Mazza Clarke



# Paprica

*Versions:* pouf. *Struttura:* legno e suoi derivati. *Imbottitura:* in poliuretano espanso a quote e qualità differenziate, fibre poliestere. *Caratteristiche:* con bottoni di serie.

*Versions:* pouf. *Structure:* in wood and by-products. *Padding:* expanded polyurethane of differentiated densities and qualities, polyester fibre. *Characteristics:* buttons included.

*Варианты:* пуф. *Структура:* дерево и его производные. *Набивка:* по умолчанию полиуретан средней жесткости (gomma), полистероловые волокна. *Характеристики:* пуговицы по умолчанию.

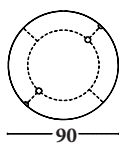
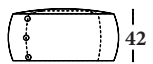

Rivestimento: 40FB5960 CAT. F Mazza Clarke  
40ID4831 CAT. E Mazza Uniti  
40ID5613 CAT. D Mazza Mar de Plata  
Bottoni: 40BE6000 CAT. E Mazza Clarke



*Forme accattivanti*







# Cerfoglio



\* misura senza cuscini

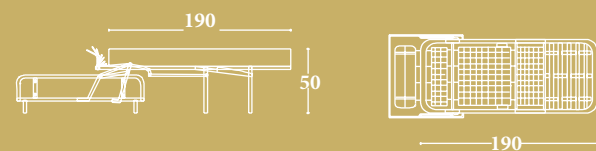
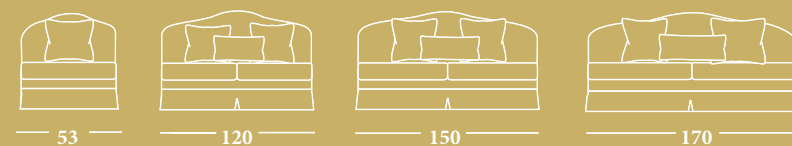
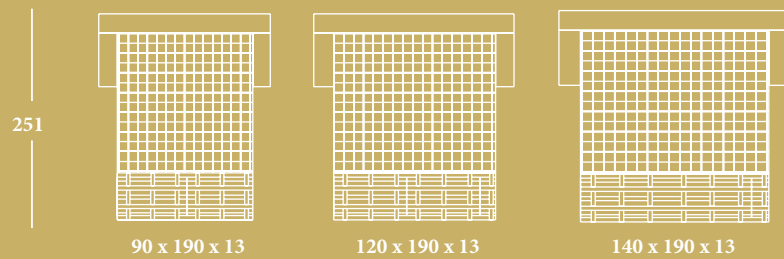

**Versioni:** poltrona, divano 2 posti, 2 posti e mezzo, 3 posti e versioni componibili con angolo tondo. Il divano 2 posti, 2 posti e mezzo e 3 posti è disponibile nella versione letto con rete elettrosaldata e materasso in fibra poliuretanica h. 13 cm. **Struttura:** legno e suoi derivati, cinghie elastiche incrociate ad alta resistenza. Nelle versioni senza letto, il supporto della seduta può essere fornito con molle elicoidali con costo aggiuntivo. **Imbottitura:** in poliuretano espanso a quote e qualità differenziate, fibre poliestere. Su richiesta, è possibile personalizzare l'imbottitura con relativi costi aggiuntivi. **Caratteristiche:** interamente sfoderabile; cuscinetti di serie; con balza e profili con bordino di serie.

**Versions:** armchair, 2-seater sofa, 2 1/2-seater, 3-seater and sectional version with round corner. The 2-seater sofa, 2 1/2-seater and 3-seater available in bed version with electrowelded frame and polyurethane mattress of 13 cm. **Structure:** in wood and by-products, high resistant strength woven elastic belts. In the version without bed, the seat support can be with helicoidal springs (additional cost). **Padding:** expanded polyurethane of differentiated densities and qualities, polyester fibre. On request is possible choose the padding (additional cost). **Characteristics:** removable covering, with volant and profiles with fringe fittings.

**Varianti:** кресло, диван 2-х, 2 ½, 3-х местный, модульные композиции с закругленным углом. Диваны 2-х, 2 ½, 3-х местные могут быть укомплектованы раскладным механизмом с металлической решеткой и полиуретановым матрасом 13 см. **Структура:** дерево и его производные, перекрещенные эластичные ремни высокой прочности. По запросу каркас дивана может быть укомплектован спиральными пружинами (за дополнительную плату) только в версии без раскладного механизма. **Набивка:** по умолчанию полиуретан средней жесткости (gomma), полистероловые волокна. По запросу можно изменить тип наполнения подушек сидения (за дополнительную плату). **Характеристики:** полностью съемный чехол, декоративные подушечки, декоративная юбка, отделка «bordino» по умолчанию.



Rivestimento: 40GU5990 CAT. G liscio  
interno schiena trapuntato

Cuscini: 40CK5896 LUSO; 40CK5901CAT. D  
Mazza Clarke

N.B. La trapuntatura è una caratteristica propria del tessuto



# Tabaseo

**Versioni:** poltrona, divano 2 posti, 2 posti e mezzo, 3 posti e pouf. Il divano 2 posti, 2 posti e mezzo e 3 posti è disponibile nella versione letto con rete elettrosaldata e materasso in fibra poliuretanica h. 13 cm. (nella versione letto alcune misure sono differenti). **Struttura:** legno e suoi derivati, cinghie elastiche incrociate ad alta resistenza. Nelle versioni senza letto, il supporto della seduta può essere fornito con molle elicoidali con costo aggiuntivo. **Imbottitura:** in poliuretano espanso a quote e qualità differenziate, fibre poliestere. Su richiesta, è possibile personalizzare l'imbottitura. **Caratteristiche:** interamente sfoderabile; con balza e profili con bordino di serie.

**Versions:** armchair, 2-seater sofa, 3-seater sofa and pouf. The 2-seater sofa, 2 1/2-seater sofa, 3-seater sofa available in bed version with electrowelded frame and polyurethane mattress of 13 cm. (the bed version some size are different) **Structure:** in wood and by-products, high resistant strength woven elastic. In the version without bed, the seat support can be with helicoidal springs (additional cost). **Padding:** expanded polyurethane of differentiated densities and qualities, polyester fibre. On request is possible choose padding. **Characteristics:** removable covering; with volant and profiles with fringe fittings.

**Варианты:** кресло, диван 2-х, 2 1/2, 3-х местный, пуф. Диваны 2-х, 2 1/2, 3-х местные могут быть укомплектованы раскладным механизмом с металлической решеткой и полиуретановым матрасом 13 см. (версии с раскладным механизмом и без раскладного механизма отличаются по размерам). **Структура:** дерево и его производные, перекрещенные эластичные ремни высокой прочности. По запросу каркас дивана может быть укомплектован спиральными пружинами (за дополнительную плату) только в версии без раскладного механизма. **Набивка:** по умолчанию полиуретан средней жесткости (gomma), полистероловые волокна. По запросу можно изменить тип наполнения подушек сидения (за дополнительную плату). **Характеристики:** полностью съемный чехол, декоративная юбка, отделка «bordino» по умолчанию.

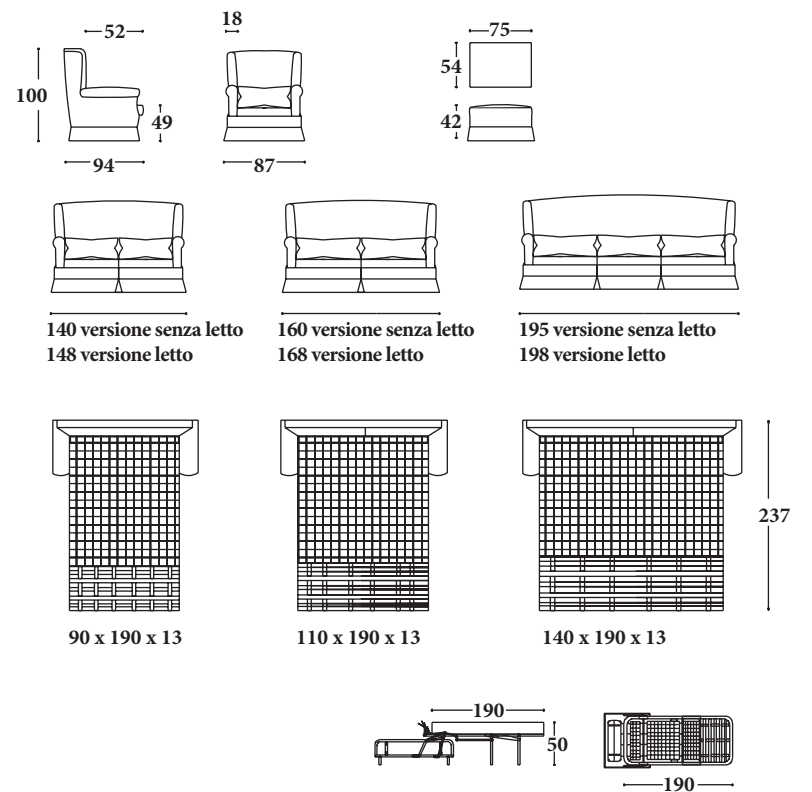



Rivestimento: 40BE5921 CAT. E  
Mazza Clarke

Curry

*Versioni:* pouf tondo. *Struttura:* legno e suoi derivati. *Imbottitura:* in poliuretano espanso a quote e qualità differenziate, fibre poliestere. *Caratteristiche:* profili con bordino di serie; su richiesta e con costo aggiuntivo, è possibile impreziosire il pouf con l'inserimento di passamaneria nei modelli e colori previsti a catalogo.

*Versions:* round pouf. *Structure:* in wood and by-products. *Padding:* expanded polyurethane of differentiated densities and qualities, polyester fibre. *Characteristics:* profiles with fringe fittings; on request is possible choose trimmings in the colors provided in the catalog (additional cost).

*Варианты:* круглый пуф. *Структура:* дерево и его производные. *Набивка:* по умолчанию полиуретан средней жесткости (gomma), полистероловые волокна. *Характеристики:* отделка «bordino» по умолчанию. По запросу (за дополнительную плату) можно добавить любую представленную в каталоге бахрому.

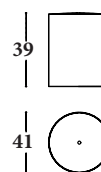

Curmino

*Versioni:* pouf quadrato. *Struttura:* legno e suoi derivati. *Imbottitura:* in poliuretano espanso a quote e qualità differenziate, fibre poliestere. *Caratteristiche:* profili con bordino di serie; su richiesta e con costo aggiuntivo, è possibile impreziosire il pouf con l'inserimento di passamaneria nei modelli e colori previsti a catalogo.

*Versions:* square pouf. *Structure:* in wood and by-products. *Padding:* expanded polyurethane of differentiated densities and qualities, polyester fibre. *Characteristics:* profiles with fringe fittings; on request is possible choose trimmings in the colors provided in the catalog (additional cost).

*Варианты:* квадратный пуф. *Структура:* дерево и его производные. *Набивка:* по умолчанию полиуретан средней жесткости (gomma), полистероловые волокна. *Характеристики:* отделка «bordino» по умолчанию. По запросу (за дополнительную плату) можно добавить любую представленную в каталоге бахрому.

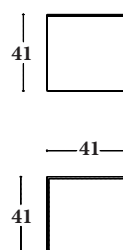

A - Rivestimento: 40FB5956 CAT. F  
Passamaneria: florence pleats 150073  
Mazza Clarke  
B - Rivestimento: 40ID4829 CAT. E  
Mazza Unifi  
Rivestimento: 40FB6060 CAT. E  
Mazza Clarke

B



A - Rivestimento: 40CK5892 CAT. G

40BE5996 CAT. E

Passamaneria: eleni braid 150055

B - Rivestimento: 40AU5963 CAT. C

Passamaneria: eleni braid 150056

C - Rivestimento: 40FB5956 CAT. F

Passamaneria: lavanta button 150047

D - Rivestimento: 40CK5896 CAT. LUSO

Passamaneria: florence pleats 150073

Mazza Clarke



Essenza del Bello







Rivestimento e coperta: 40ID4831 CAT. E  
Mazza Uniti









Rivestimento: 40ID4831 CAT. E  
Piumone ART722A 40ID4831 CAT. E  
Mazza Uniti  
Finitura: bianco antico col. 29







## Zafferano

*Versioni:* poltrona. *Struttura:* legno e suoi derivati, cinghie elastiche incrociate ad alta resistenza. *Imbottitura:* in poliuretano espanso a quote e qualità differenziate, fibre poliestere. Su richiesta, è possibile personalizzare le imbottiture. *Caratteristiche:* interamente sfoderabile; la finitura della base in legno è disponibile nei colori previsti a catalogo; profili con bordino di serie.

*Versions:* armchair. *Structure:* in wood and by-products, high resistant strength woven elastic belts. *Padding:* expanded polyurethane of differentiated densities and qualities, polyester fibre. On request is possible choose the padding (additional cost). *Characteristics:* removable covering; finishing for base in wood is available in different colors in the catalog; profiles with fringe fittings.

*Варианты:* кресло. *Структура:* дерево и его производные, перекрещенные эластичные ремни высокой прочности. *Набивка:* по умолчанию полиуретан средней жесткости (gomma), полистероловые волокна. По запросу можно изменить тип наполнения подушек сидения (за дополнительную плату). *Характеристики:* полностью съемный чехол, окраска деревянного каркаса в серийных отделах, отделка «bordino» по умолчанию.

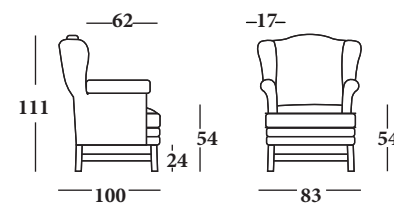



Rivestimento: 40ID4831 CAT. E  
Bordino: 40ID4830 CAT. E  
Mazza Uniti  
Finitura: colore 23







Rivestimento: 40GU5988 CAT. G

Mazza Clarke

Bordo: 40VI5584 CAT. F

Mazza velluti e sete

Scaldotto ART794 40CK5908 CAT. G

Mazza Clarke

Piumone ART722A 40ID4831 CAT. E

Mazza Uniti

N.B. La trapuntatura è una caratteristica

propria del tessuto





# Essenza del Design









## Lemongrass

*Versioni:* pouf. *Struttura:* pedana in legno e suoi derivati con ruote girevoli di cui 2 con fermo. *Imbottitura:* in poliuretano espanso a quote e qualità differenziate, fibre poliestere. Su richiesta, è possibile personalizzare l'imbottitura. *Caratteristiche:* la finitura della base in legno è disponibile nei colori previsti a catalogo.

*Versions:* pouf. *Structure:* dais in wood and by-products with castors, two with brake. *Padding:* expanded polyurethane of differentiated densities and qualities, polyester fibre. On request, is possible choose the padding (additional cost). *Characteristics:* painting the wooden base is available in the colors provided in the catalog.

*Варианты:* пуф. *Структура:* подставка - дерево и его производные, вращающиеся колеса, 2 с тормозом. *Набивка:* по умолчанию полиуретан средней жесткости (gomma), полистероловые волокна. По запросу можно изменить тип наполнения подушек сидения (за дополнительную плату). *Характеристики:* окраска деревянного каркаса в серийных отделах.

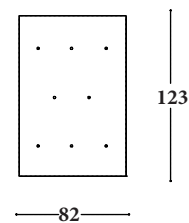
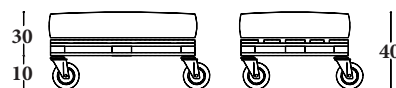



Rivestimento: 40MC5890 CAT. G  
Mazza Clarke  
Finitura: RAL celeste 5012



*Sofisticata eleganza*









## Creuma

*Versioni:* poltrona. *Struttura:* legno e suoi derivati, cinghie elastiche incrociate ad alta resistenza. *Imbottitura:* in poliuretano espanso a quote e qualità differenziate, fibre poliestere. Su richiesta, è possibile personalizzare l'imbottitura. *Caratteristiche:* piedi a vista di serie.

*Versions:* armchair. *Structure:* in wood and by-products, high resistant strength woven elastic belts. *Padding:* expanded polyurethane of differentiated densities and qualities, polyester fibre. On request is possible choose padding. *Characteristics:* visible feet included.

*Варианты:* кресло. *Структура:* дерево и его производные, перекрещенные эластичные ремни высокой прочности. *Набивка:* по умолчанию полиуретан средней жесткости (gomma), полистероловые волокна. По запросу можно изменить тип наполнения подушек сидения (за дополнительную плату). *Характеристики:* серийные видимые ножки.

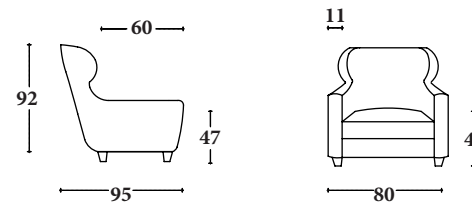

H piede anteriore 15  
H piede posteriore 12



Rivestimento: 40VI5584 CAT. F  
Bordino: 40VI5586 CAT. F  
Mazza Velluti e Sete





*Divere contemporaneo*



# Pepe

---

*Versioni:* poltrona. *Struttura:* legno e suoi derivati, cinghie elastiche incrociate ad alta resistenza. *Imbottitura:* in poliuretano espanso a quote e qualità differenziate, fibre poliestere. *Caratteristiche:* piedi a vista di serie.

*Versions:* armchair. *Structure:* in wood and by-products, high resistant strength woven elastic belts. *Padding:* expanded polyurethane of differentiated densities and qualities, polyester fibre. *Characteristics:* visible feet included.

*Варианты:* кресло. *Структура:* дерево и его производные, перекрещенные эластичные ремни высокой прочности. *Набивка:* по умолчанию полиуретан средней жесткости (gomma), полистероловые волокна. *Характеристики:* серийные видимые ножки.

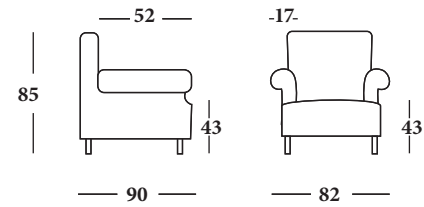

H piede anteriore 18  
H piede posteriore 14



Rivestimento: 40AU5964 CAT. C Mazza Clarke

Cuscino: 40ZO5806 CAT. B Mazza Uniti

Finitura: colore 24



# Senape

*Versioni:* pouf. *Struttura:* legno e suoi derivati. *Imbottitura:* in poliuretano espanso a quote e qualità differenziate, fibre poliestere. *Caratteristiche:* piedi a vista nei colori previsti a catalogo.

*Versions:* pouf. *Structure:* in wood and by-products. *Padding:* expanded polyurethane of differentiated densities and qualities, polyester fibre. *Characteristics:* visible legs colors provided in the catalog.

*Варианты:* пуф. *Структура:* дерево и его производные. *Набивка:* по умолчанию полиуретан средней жесткости (gomma), полистероловые волокна. *Характеристики:* видимые ножки в серийных отделках.

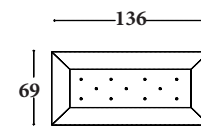
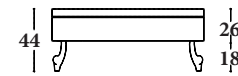



Rivestimento: 40AU5964 CAT. C  
Mazza Clarke  
Piano superiore e bordino: 40MC4768 CAT. B  
Mazza Uniti



# Eucalipto

*Versioni:* pouf 60x45, 120x48, 92x92. *Struttura:* legno e suoi derivati. *Imbottitura:* in poliuretano espanso a quote e qualità differenziate, fibre poliestere. *Caratteristiche:* piedi a vista nei colori previsti a catalogo.

*Versions:* pouf 60x45,120x48,92x92. *Structure:* in wood and by-products. *Padding:* expanded polyurethane of differentiated densities and qualities, polyester fibre. *Characteristics:* visible legs colors provided in the catalog.

*Варианты:* пуф 60x45, 120x48, 92x92. *Структура:* дерево и его производные. *Набивка:* по умолчанию полиуретан средней жесткости (gomma), полистероловые волокна. *Характеристики:* видимые ножки в серийных отделках.

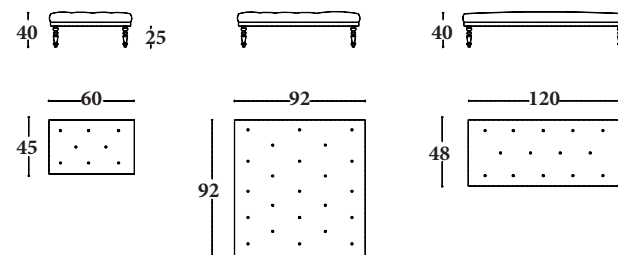



Rivestimento: Patchwork

Complementi



# Rafia e Pimento

---



barletta bobble 150030



eleni braid 150056



levanta button 150047



florence pleats 150067



picot braid 150061



vivalto tieback 150082



bellini beads 150039



florence pleats 150065

# Seafoam & Willow



barletta bobble 150035

# Marine & Aqua



barletta bobble 150034



levanta button 150052



levanta button 150053



florence pleats 150072



bellini beads 150044



bellini beads 150042



picot braid 150063



vivalto tieback 150083



vivalto tieback 150078

# Amethist & Chartreuse

---



eleni braid 150057



barletta bobble 150033



bellini beads 150041



bellini beads 150045



florence pleats 150073



florence pleats 150070



lavanta button 150050



vivalto tieback 150080



picolt braid 150060



vivalto tieback 150079

# Peony & Lapis



barletta bobble 150031



levanta button 150054



florence pleats 150069



bellini beads 150040



florence pleats 150071

# Raspberry & Lime



barletta bobble 150034



levanta button 150048



picot braid 150068



vivalto tieback 150084



vivalto tieback 150081

# Brown & Lime

---



barletta bobble 150036



florence pleats 150064



eleni braid 150055



florence pleats 150073



lavanta button 150051



vivalto tieback 150077



bellini beads 150046



eleni braid 150058

# Linen & Prewier



barletta bobble 150037



barletta bobble 150038



eleni braid 150059



florence pleats 150066



lavanta button 150049



bellini beads 150043



picot braid 150062



vivalto tieback 150075



vivalto tieback 150076



vivalto tieback 150074

# Tende

---

Cat. G - H. 280  
95% lino - 5% cotone  
con ricamo



*giacomo nativ nativ*



Cat. G - H. 280  
95% lino - 5% cotone  
con ricamo



*giacomo blanco marfil*



Cat. G - H. 280  
100% lino  
con ricamo



*hesat nativ*



Cat. G - H. 280  
50% lino - 50% xxxxx



*eireon ivory*



Cat. G - H. 280  
100% lino  
con ricamo



*ealypro marfil lino*



Cat. G - H. 280  
95% lino - 5% cotone  
con applicazione



*bolero natur*





ART029 cuscino 40x40  
con bordino



ART034 cuscino 60x60  
con bordino



ART053 cuscino 50x50  
con bordino



ART084 cuscino 50x50  
con volant



ART102 cuscino 45x45  
con bordino



ARTA75 cuscino 45x45 a busta  
con fiocco



ARTA76 cuscino 40x65  
con bordino



ARTA77 cuscino 30x48  
con bordino



ARTA78 cuscino 45x45  
con bordino e bottone



ARTB06 cuscino 35x60  
con bordino



ARTB09 cuscino fiore D40



ARTB13 cuscino 60x60  
con piping (bordo XL)



ARTB14 cuscino 40x40  
con doppio tessuto



ARTB15 cuscino 40x65  
con doppia lavanta button



ARTB16 cuscino 30x60  
con due bottoni



ARTB17 cuscino 50x50  
con volant e bottone



ARTB18 cuscino 55x55  
con sfere agli angoli



ARTB19 cuscino 40x65  
con florence pleats



ARTB20 rullo D17x62  
con bottone



ARTB21 cuscino D45  
con fascia H10



ARTB22 cuscino D45 con fascia H10  
con eleni braid



ARTB23 cuscino 50x30  
con lavanta button



ARTB24 cuscino 50x30  
con lavanta button+eleni braid



ARTB25 cuscino 40x40  
con bordo plissé



ARTB26 cuscino 60x30  
con bordo plissé



ARTB27 cuscino 45x35 con  
tessuto sfibrato+trinette ai lati

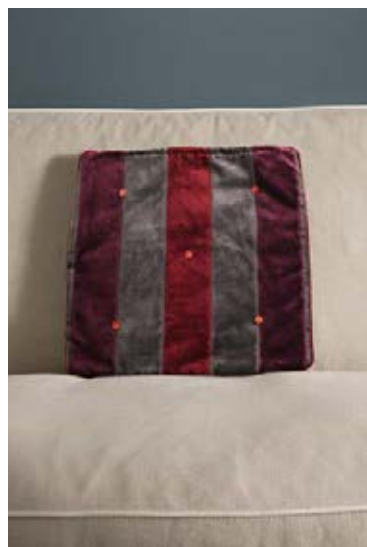

ARTB28 cuscino 45x45 vuoto  
con bottoni



ARTB29



ARTB30



ARTB31

# Complementi

---



ART760A



ART768



ART832 rullo 80 cm - ART833 rullo 120 cm -  
ART834 rullo 160 cm



ART722B



ART794



ART722A



CRETA01 - h 22



CRETA02 - h 22



CRETA03 - h 28



CRETA04 - h 28



CRETA05 - h 35



CRETA06 - h 18



CRETA07 - h 35



CRETA08 - h 35



CRETA09 - h 50



CRETA10



CRETA11



CRETA12



CRETA13 - h 35



CRETA14 - h 70



CRETA15 - h 40

*Prodotto fatto a mano. Piccole imperfezioni e irregolarita' non sono difetti ma caratteristiche che rendono autentico e singolare ogni nostro articolo.*



CRETA16 - h 25



CRETA17 - h 30



CRETA18 - h 40



CRETA19 - h 50



CRETA20 - h 30



CRETA21 - h 5



CRETA22 - h 8



CRETA23 - h 9



CRETA24 - h 12



CRETA25 - h 13



CRETA26 - h 30



CRETA27 - h 25



CRETA28 - h 55



CRETA29 - h 20



CRETA30 - h 24

*Prodotto fatto a mano. Piccole imperfezioni e irregolarita' non sono difetti ma caratteristiche che rendono autentico e singolare ogni nostro articolo.*



CRETA31 - h 43



CRETA32 - h 65



CRETA33 - h 65



CRETA34



CRETA35



CRETA36



CRETA37



CRETA38



PAR01  
D.45 H45 L 004



PAR02  
D.30 H 20 L001



PAR03  
D.30 H 30 L002

# Finiture e colori

---



Col. 21 noce medio



Col. 22 noce chiaro



Col. 23 noce scuro



Col. 24 foglia argento



Col. 25 foglia old silver



Col. 26 foglia oro



Col. 27 white e gold



Col. 28 bianco



Col. 29 bianco antico



Col. 30 scrape white



Col. 34 moka



Col. 35 grigio fume



Col. 36 bianco lucido



Col. 37 nero lucido



Col. 38 crema tortora



Col. 39 cenere



Col. 40 sabbia

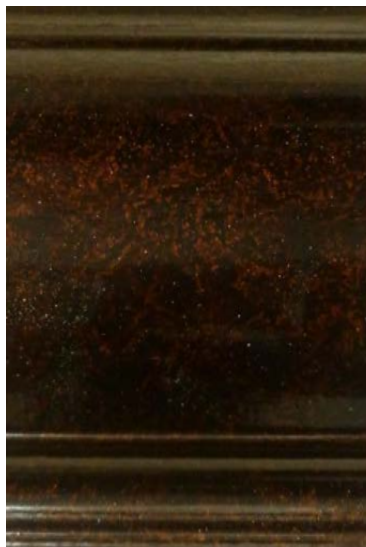

Col. 41 radica scuro



Col. 42 cerusè seppia



Col. 43 foglia oro patinato bianco



Col. 44 bianco argento



Col. 45 foglia argento spazzolata a mano



Col. 46 foglia oro spazzolata a mano



Col. 47 crema



RAL 1032 - giallo ginestra



RAL 2000 - arancio giallo



RAL 2002 - arancio sangue



RAL 3027 - rosso lampone



RAL 4009 - viola pastello



RAL 5005 - blu segnale



RAL 4010 - tela magenta



RAL 5021 - blu acqua



RAL 6002 verde foglia



RAL 4012 - mora perlato



RAL 4003 - fuxia



RAL 5012 - celeste

## IMBOTTITURA CUSCINI SEDUTA



CUSCINO IN POLIURETANO 35RS STANDARD



CUSCINO IN POLIURETANO WATERLILY (OPZIONE)

Particolarmente confortevole ed indeformabile ha nelle sue caratteristiche tecniche materie prime ecologiche a base di acqua. Seduta esclusiva e brevettata studiata dal nostro ufficio tecnico a sostegno inferiore in densità 35 che dona più stabilità alla seduta. E' possibile utilizzarlo su richiesta, su tutte le sedute dei modelli con modesto costo aggiuntivo.



CUSCINO IN PIUMA D'OCA PIUMEX PROVENCE (OPZIONE)

Imbottitura cuscino con strato superiore in piuma con tela spigata 100% cotone suddivisa in zone a pesi differenziati e base inferiore in poliuretano speciale. Questa soluzione, studiata e mixata dal nostro ufficio tecnico, permette di ottenere il comfort della piuma e un' adeguata stabilità della seduta. E' possibile utilizzarlo su tutti i modelli con lieve costo aggiuntivo.



CUSCINO IN PIUMA D'OCA DOPPIO STRATO (OPZIONE)

Imbottitura cuscini piuma con tela spigata 100% cotone suddivisa in zone a pesi differenziati. Interno in piuma d'oca, con uno strato centrale di waterlily. Sistema esclusivo studiato dal nostro ufficio tecnico che permette di avere il massimo comfort della piuma, lasciando quasi invariata l'estetica del cuscino che grazie al waterlily ritorna perfettamente intatto. E' possibile utilizzarlo su tutti i modelli con moderato costo aggiuntivo.



CUSCINO IN POLIURETANO 50 VISCOELASTICO MEMORY (OPZIONE)

Garantito nel tempo, molto confortevole ha nelle sue caratteristiche una seduta soft ed ergonomica che assume qualunque forma del corpo rendendo la seduta molto gradevole. La stessa è dotata di una particolare memoria che permette di riassumere la posizione iniziale; ha un sostegno inferiore che dona più stabilità alla seduta. E' possibile utilizzarlo su richiesta, su tutte le sedute dei modelli con lieve costo aggiuntivo.

## SCHEDA TECNICA LETTI IMBOTTITI



### BASE SOLLEVABILE CON RETE IN LEGNO:

Struttura in legno, rete a doghe in legno sollevabile che permette di utilizzare lo spazio interno del box. La base è corredata di copirete. SU RICHIESTA E' DISPONIBILE LA VERSIONE DIVISA IN DUE PARTI E LA VERSIONE SMONTABILE CON PREZZO AGGIUNTIVO.

### LIFTING FRAME WITH WOODEN LISTS:

Wooden structure, lifting frame with wooden lists which allows to use the internal box space. Frame supplied with cover. ON REQUEST IS AVAILABLE THE VERSION DIVIDED IN TWO PARTS AND THE VERSION WHICH CAN BE DISASSEMBLED (ADDITIONAL COST).

### БАЗА С ПОДЪЕМНЫМ МЕХАНИЗМОМ И ДЕРЕВЯННОЙ РЕШЕТКОЙ:

Каркас из дерева, подъемная деревянная решетка с лами, позволяющая использовать внутреннее пространство контейнера. База укомплектована чехлом для решетки. По запросу возможна как версия основания из 2 частей, и полностью разборное основание за дополнительную плату.



### BASE IN LEGNO SOMMIER:

Struttura in legno rivestita in vellutino accoppiato. La base è corredata di copirete. SU RICHIESTA E' DISPONIBILE LA VERSIONE DIVISA IN DUE PARTI CON PREZZO AGGIUNTIVO.

### WOODEN FRAME (SOMMIER):

Wooden structure with velvet upholstery. Frame supplied with cover. ON REQUEST IS AVAILABLE THE VERSION DIVIDED IN TWO PARTS (ADDITIONAL COST).

ОСНОВАНИЕ ИЗ ДЕРЕВА: SOMMIER - ПОЛНОСТЬЮ ДЕРЕВЯННОЕ ЦЕЛЬНОЕ ОСНОВАНИЕ БЕЗ ДОПОЛНИТЕЛЬНЫХ ФУНКЦИЙ, НЕ ПРЕДУСМОТРЕНО ИСПОЛЬЗОВАНИЕ ДОПОЛНИТЕЛЬНОЙ РЕШЕТКИ. Каркас из дерева обшитый двойной лентой. База укомплектована чехлом для решетки. По запросу возможна версия основания из 2 частей за дополнительную плату.



### BASE FISSA CON RETE A DOGHE IN LEGNO:

Struttura in legno, rete con doghe con profilo metallico corredata di un igienico copirete. SU RICHIESTA E' DISPONIBILE LA VERSIONE DIVISA IN DUE PARTI (COSTO AGGIUNTIVO).

### FIXED FRAME WITH WOODEN LISTS:

Wooden structure, frame with lists and metallic border; supplied with a hygienic cover. ON REQUEST IS AVAILABLE THE VERSION DIVIDED IN TWO PARTS (ADDITIONAL COST).

### ФИКСИРОВАННАЯ БАЗА С ДЕРЕВЯННОЙ РЕШЕТКОЙ С ЛАГАМИ (A DOGHE):

каркас из дерева, решетка с лами с металлическим профилем, укомплектована чехлом для решетки. По запросу возможна версия основания из двух частей (за дополнительную плату).



### BASE SOLLEVABILE CON RETE IN LEGNO A DUE MOVIMENTI:

Struttura in legno, rete a doghe in legno sollevabile a due movimenti che permette di sistemare comodamente le lenzuola e di utilizzare lo spazio interno del box. La base è corredata di copirete. SU RICHIESTA E' DISPONIBILE LA VERSIONE DIVISA IN DUE PARTI E LA VERSIONE SMONTABILE CON PREZZO AGGIUNTIVO.

### LIFTING FRAME WITH TWO MOVEMENTS WITH WOODEN LISTS:

Wooden structure, with two movements lifting frame with wooden lists which allows to put in the sheets and blankets and to use the internal box space. Frame supplied with cover. ON REQUEST IS AVAILABLE THE VERSION DIVIDED IN TWO PARTS AND THE VERSION WHICH CAN BE DISASSEMBLED (ADDITIONAL COST).

### БАЗА С 2-Х ПОЗИЦИОННЫМ ПОДЪЕМНЫМ МЕХАНИЗМОМ И ДЕРЕВЯННОЙ РЕШЕТКОЙ:

Каркас из дерева, подъемная 2-х позиционная деревянная решетка с лами, позволяющая удобнейшим образом заправлять постель и использовать внутреннее пространство контейнера. База укомплектована чехлом для решетки. По запросу возможна как версия основания из 2 частей, и полностью разборное основание за дополнительную плату.





Base divisa in due parti nella versione SOMMIER.

Base in two parts in the version SOMMIER.

Основание разделено на 2 части в версии SOMMIER.



BASE SMONTABILE.

Disponibile nella versione base con rete fissa e base con rete sollevabile a due movimenti. Pannelli in legno, rete a doghe in legno corredata di coprirete. Completamente smontabile per agevolare il trasporto.

FRAME WHICH CAN BE DISASSEMBLED.

Available with base with fixed frame and base with lifting frame and base with two movements. wooden panels, frame with wooden lists supplied with cover. The frame can be completely disassembled to make transport easier.

РАЗБОРНЫЕ ОСНОВАНИЯ.

возможны для версий — основание с фиксированной решеткой или подъемным механизмом с двухпозиционным открыванием. деревянные панели, решетка с деревянными ла укомплектована ч лхом для решетки. полностью разбирающаяся для о легчения транспортировки.







